

Clarke® CONTRACTOR®



70L INDUSTRIAL DEHUMIDIFIER

MODEL NO: IDH70L

PART NO: 6470613

OPERATION & MAINTENANCE INSTRUCTIONS



DL0624 Rev1

INTRODUCTION

Thank you for purchasing this CLARKE 70 Litre Industrial Dehumidifier.

Before attempting to use this product, please read this manual thoroughly and follow the instructions carefully. In doing so you will ensure the safety of yourself and that of others around you, and you can look forward to your purchase giving you long and satisfactory service.

GUARANTEE

This product is guaranteed against faulty manufacture for a period of 12 months from the date of purchase. Please keep your receipt which will be required as proof of purchase.

This guarantee is invalid if the product is found to have been abused or tampered with in any way, or not used for the purpose for which it was intended.

Faulty goods should be returned to their place of purchase, no product can be returned to us without prior permission.

This guarantee does not effect your statutory rights.

ENVIRONMENTAL RECYCLING POLICY



Recycle unwanted materials instead of disposing of them as waste. All unwanted accessories and packaging should be sorted and taken to a recycling centre for disposal in a manner which is compatible with the environment.



By purchasing this product, the customer is taking on the obligation to deal with its safe disposal in accordance with the Waste Electrical and Electronic Equipment regulations (WEEE).

In effect, this means that this product must not be disposed of with general household waste. It must be disposed of according to the laws governing Waste Electrical and Electronic Equipment (WEEE) at a recognised disposal facility.

R290 is a refrigerant that complies with EEC environmental standards; nonetheless, the refrigerant circuit on the machine should not be punctured. At the end of its working life, consign the dehumidifier unit to a special collection centre.

ELECTRICAL CONNECTIONS



WARNING! READ THESE ELECTRICAL SAFETY INSTRUCTIONS THOROUGHLY BEFORE CONNECTING THE PRODUCT TO THE MAINS SUPPLY.

Before switching the product on, make sure that the voltage of your electricity supply is the same as that indicated on the rating plate. This product is designed to operate on 230VAC 50Hz. Connecting it to any other power source may cause damage.

This product may be fitted with a non-rewireable plug. If it is necessary to change the fuse in the plug, the fuse cover must be refitted. If the fuse cover becomes lost or damaged, the plug must not be used until a suitable replacement is obtained.

If the plug has to be changed because it is not suitable for your socket, or due to damage, it should be cut off and a replacement fitted, following the wiring instructions shown below. The old plug must be disposed of safely, as insertion we would emphasise the electrical hazard.



**WARNING: WIRES IN THE MAINS LEAD ARE COLOURED IN ACCORDANCE WITH THE FOLLOWING CODE:
GREEN/YELLOW = EARTH, BLUE = NEUTRAL, BROWN = LIVE.**

- The **BLUE** wire must be connected to the terminal marked N or coloured black.
- The **BROWN** wire must be connected to the terminal marked L or coloured red.
- The **YELLOW AND GREEN** wire must be connected to the terminal marked E or \perp or coloured green.

Plug must be BS1363/A approved.

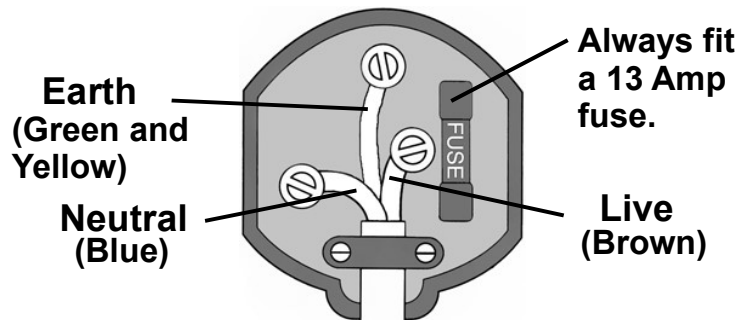

Ensure that the outer sheath of the cable is firmly held by the clamp

We strongly recommend that this machine is connected to the mains supply via a Residual Current Device (RCD).

If in any doubt, consult a qualified electrician. **DO NOT** attempt any repairs yourself.

OVERVIEW



No.	Description
1	Handle
2	Control Panel
3	Air Outlet
4	Lifting Handle
5	2 x Wheels
6	2 x Feet
7	16mm x 90cm Drainage Pipe
8	Carbon Air Filter Pull Tab
9	Air Inlet and Carbon Air Filter

SAFETY WARNINGS



WARNING: IF THE SUPPLY CABLE IS DAMAGED, IT MUST BE REPLACED BY THE MANUFACTURER, ITS SERVICE AGENT OR SIMILARLY QUALIFIED PERSONS IN ORDER TO AVOID A HAZARD.

1. Please read these instructions carefully and retain for future reference.
2. Position the mains cable so that it cannot be inadvertently pulled or pinched and where it does not cause a trip hazard.
3. This appliance is designed to dehumidify industrial environments and **MUST NOT** be used for other purposes.
4. If the appliance requires repair, **ALWAYS** contact your CLARKE dealer. **ALWAYS** insist on original spare parts. Repairs carried out by unauthorized persons may be dangerous and invalidate the guarantee.
5. Children **SHOULD NOT** play with the appliance. Cleaning and user maintenance **SHOULD NOT** be undertaken by children.
6. Before cleaning or maintenance operations, **ALWAYS** unplug the appliance from the power supply.
7. **DO NOT** move the appliance by pulling the power cable.
8. **DO NOT** install the appliance in rooms containing gas, oil or fuel.
9. **DO NOT** install near sources of heat.
10. **DO NOT** use the appliance on inclined surfaces.
11. Keep the appliance away from inflammable substances (alcohol etc) or pressurised containers (e.g. aerosol cans).
12. **DO NOT** rest heavy or hot objects on top of the appliance.
13. **ALWAYS** transport the appliance upright. **Wait at least 1 hour after transporting the appliance before using it to allow the refrigerant gasses to settle.**
14. **DO NOT** use the appliance outdoors.
15. **DO NOT** obstruct the air inlet or outlet.
16. **DO NOT** use means to accelerate the defrosting process or to clean, other than those recommended in this manual.
17. **DO NOT** store in a room continuously operating ignition sources like open flames, operating gas appliance or electric heater.
18. **DO NOT** cover the dehumidifier when in use. Place at least 50cm (100cm from front) from walls, doors, windows or obstructions.



WARNING: DO NOT USE OR STORE THE DEHUMIDIFIER NEAR A HEAT SOURCE, AS THE UNIT CONTAINS PRESSURISED FLAMMABLE REFRIGERANT GAS (R290-HYDROCARBON PROPANE)

R290 REFRIGERANT GAS (HYDROCARBON PROPANE)



H220: Extremely Flammable Gas.



H280: Contains Gas Under Pressure, May Explode if Heated.

R290 refrigerant gas complies with UK & European environmental directives.

R290 has a low GWP (Global Warming Potential) of 3 and CO₂ equivalent to 0.00084t.

The dehumidifier contains approximately 280g of R290 refrigerant gas. The refrigerant system **MUST NOT** be perforated or punctured.

- **DO NOT** use or store in an unventilated space with an area smaller than 4m² per unit. The room must be such as to prevent stagnation of possible leaks of refrigerant gas as there could be a danger of fire or explosion hazard should the refrigerant come into contact with electric heaters, stoves or other sources of ignition.
- Refrigerant gas may be odourless.
- **DO NOT** use the product and contact the retailer for advice if damage has occurred to the unit which may have compromised the refrigerant system.
- Any repairs or maintenance must only be carried out on the unit by a suitably qualified engineer. Before opening and servicing the unit, the authorized engineer must be in possession of a copy of the manufacturer's service manual and must follow the safety information contained within it to ensure all hazards are minimized.

ASSEMBLY

- Align the fixing holes of the tubular handle with the holes on the rear of the dehumidifier.
- Fix the handle to the dehumidifier using the 4 fixing screws supplied, as shown.

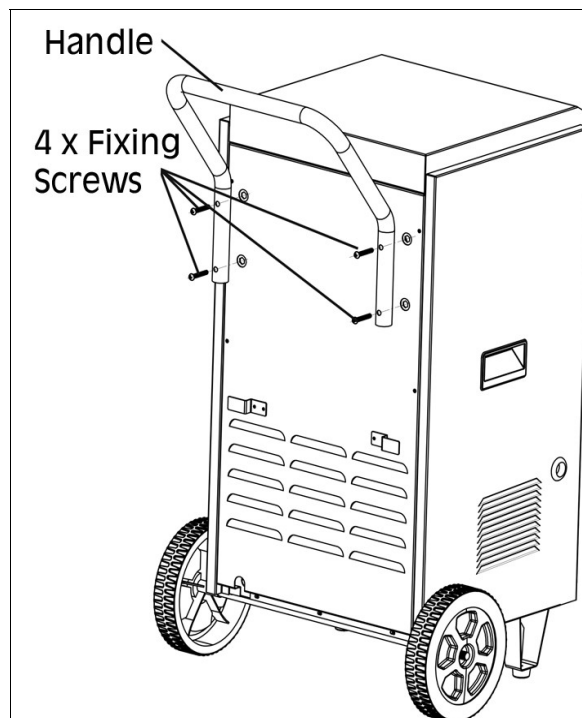

WHEELS

1. Incline the machine body, as shown, and fix the axle on the bottom of the machine body using the 4 screws.
2. Using the nuts and washers, fix the wheels to the axle rod.

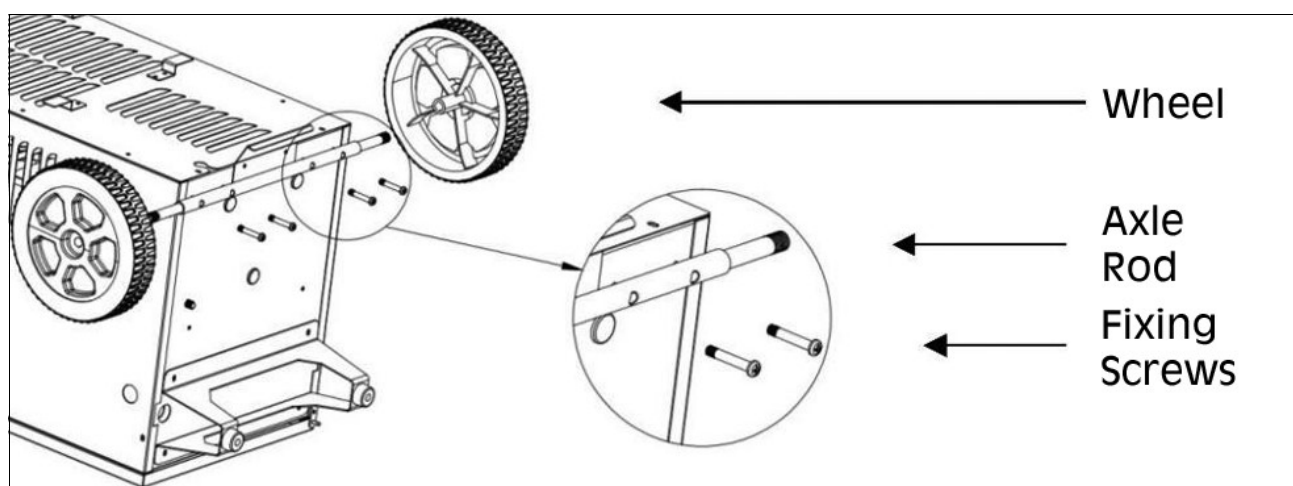

3. Once the wheels have been installed, place the machine in the upright position.

NOTE: Once assembly is complete, leave the machine to stand for a minimum of 1 hour, this is for the refrigeration gases to settle before use.

OPERATION

CONTROL PANEL

1 = DISPLAY SCREEN

2 = POWER INDICATOR LIGHT

3 = TIMER INDICATOR LIGHT

4 = ON/OFF BUTTON

5 = TIMER SET BUTTON

6 = INCREASE SET TIMER/HUMIDITY BUTTON

7 = DECREASE SET TIMER/HUMIDITY BUTTON

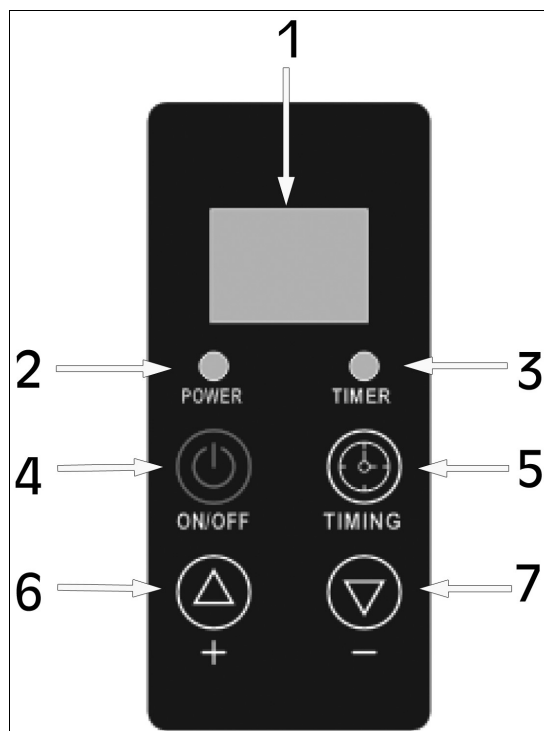

Button	Operation Instructions
On/Off (Button 4)	Switches the machine On and Off
+ (Button 6)	Adjusts different set values in different states: 1: Increases the humidity value set (RH 10% to 95%) 2: Increases the timing (Hours) set (00 to 24)
- (Button 7)	Adjusts different set values in different states: 1: Decreases the humidity value set (RH 10% to 95%) 2: Decreases the timing (Hours) set (00 to 24)
Timing (Button 5)	Short press the button to launch a cycle to Off. Set On/Off timer and exit

CONTINUOUS DRAINING

This dehumidifier does not contain an internal water tank. An external prefitted drainage pipe enables continuous dehumidifying without having to empty a water tank.

PREPARATION FOR CONTINUOUS DRAINING:

1. Locate the prefitted external drainage pipe on the side of the machine.
2. Place the pipe into a suitable receptacle/drain ensuring that the end of the pipe is below the level of the outlet in the unit body.

NOTE: If using a receptacle, make sure it is large enough as the machine can produce up to 70 litres of water in a 24 hour period.

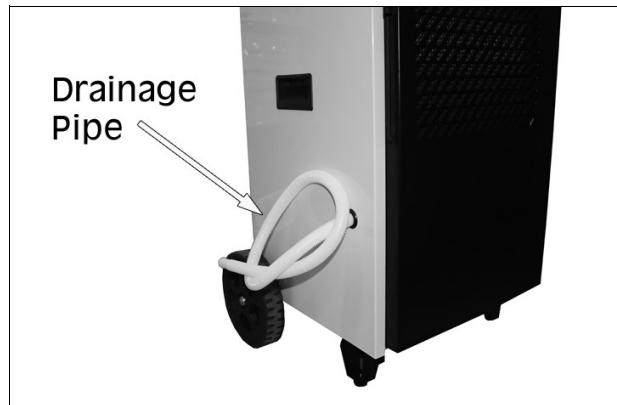

NOTE: The pipe has a diameter of 16mm and is 90cm long.

NOTE: DO NOT submerge the end of the pipe in water, as this may cause water to be drawn back up into the machine.

TIMING AND ON/OFF FUNCTION

When the machine is powered on, you can set the timer to power off; and when the machine is powered off, you can set the timer to power on. Setting the timer for both powering on and off will initiate the cycle timer mode.

SETTING OF TIMER - POWER ON

1. When the machine is powered off, press the "Timing" button.
2. The "Timing On" icon will flicker and the time set will flicker on the display screen.
3. Press the "+" or "-" buttons to adjust the timing. The dehumidifier will make a sound once the button is pressed. The time set will increase or decrease by "1", holding the button for 2 seconds will continually increase or decrease the time.
4. Once the required time is set, non-action of the buttons for 10 seconds the dehumidifier will accept the new setting and the "Timing On" icon will flicker (Ranging from 0 to 24 hours, and 0 hours as default).

SETTING OF TIMER - POWER OFF

1. When the machine is powered on, press the "Timing" button.
2. The "Timing Off" icon will flicker and the time set will flicker on the display screen.
3. Press the "+" or "-" buttons to adjust the timing. The dehumidifier will make a sound once the button is pressed. The time set will increase or decrease

by “1”, holding the button for 2 seconds will continually increase or decrease the time.

4. Once the required time is set, non-action of the buttons for 10 seconds the dehumidifier will accept the new setting and the “Timing Off” icon will flicker (Ranging from 0 to 24 hours, and 0 hours as default).

HUMIDITY CONTROL

- When the rooms humidity value is 3% lower than the set humidity on the machine, the compressor will shut down, the fan will delay shut down for 3 minutes and then shut down; and when it is 3% higher than the humidity value set on the machine, both the fan and compressor will start to operate.
- When the humidity is set at the minimum value (10%), the machines default will enter the continuous dehumidifying mode.
- When started, the compressor will start 3 seconds later and when it is shut down, the fan will run for 3 seconds.
- If a fault of the humidity sensor occurs, the machine will turn to the continuous dehumidifying mode.
- If a fault of the coil sensor occurs, the machine will turn to the timing defrosting mode (See Defrosting Mode).

PROTECTION FUNCTION

- Once shut down, the compressor will take 3 minutes to restart. Quick start is available for the first power-on.
- **Power off memory:** For abrupt power outage or accidental unplugging, the machine will automatically return to the operating state right before the ‘incident’, and continue at that state for the next power-on.

DISPLAY CODES

Display Code	Instruction	Action
E1	Fault with coil sensor	See Defrosting Mode on Page 11.
E2/E3	Fault with humidity and/or temperature sensor	Replace temperature and humidity sensor.
EE	Refrigerant leakage	Turn off machine and contact CLARKE service department.

DEFROSTING MODE

Defrosting Mode	Description	
Automatic Defrosting	Sensor at Normal State	<p>1: If the compressor constantly runs for over 20 minutes or if the coil temperature is below 0°C constantly for over 30 minutes, it will start the defrosting mode.</p> <p>2: If the coil temperature is over 5°C for a 90 second period, or the defrosting time is over 8 minutes, it will stop the defrosting mode.</p>
Defrosting Faults	Coil Sensor Fault (E1 displayed)	<p>1: When ambient temperature is over 25°C it will not start a defrosting cycle.</p> <p>2: When ambient temperature is below 25°C but higher than 15°C the compressor will run constantly for 30 minutes, it will defrost for 10 minutes of the 30 minute period.</p> <p>3: When ambient temperature is below 15°C but higher than 4°C the compressor will run constantly for 20 minutes, it will defrost for 12 minutes of the 20 minute period.</p>
	Temp-damp Sensor Fault	If the compressor constantly runs for over 20 minutes or if the coil temperature is below 0°C constantly for over 20 minutes, it will start the defrosting mode.
	Coil Sensor and Temp-damp Sensor Faults	<p>1: The compressor will run constantly for 40 minutes, it will defrost for 10 minutes of the 40 minute period.</p> <p>2: Coil temperature over 5°C for a 90 second period, or defrosting time over 25 minutes, it will stop the defrosting mode.</p>





TROUBLESHOOTING

	Cause	Solution
No operation (Shown as no power)	Power outage	Check if the power supply is in working order. Confirm the plug is correctly inserted in the power socket.
	Fuse in plug or fuse board blown	Replace the relevant fuse.
	No operation (Shown as power on)	Environmental humidity lower than the set value
	The machine is defrosting	Wait for defrosting to complete.
Dehumidifier function not effective	If a door or window are open	Close the door or window.
	Room temperature is too low	DO NOT use the dehumidifier.
	Room temperature too high, humidity too low.	In dry conditions the dehumidification ability will reduce.
	Air filter blocked.	Remove any dirt or obstruction from the air intake.
Noise is abnormal during operation	Dehumidifier is positioned incorrectly.	Check that dehumidifier is placed on a flat level surface.
	Air filter blocked.	Remove any dirt or obstruction from the air intake.
	There is a 'tittering' sound.	This is the flow of the refrigerant, which is a normal phenomenon.
Water Leak	Connection of drainage pipe become loose.	Check pipe connection.
	Drainage system is blocked.	Remove obstacle and straighten out drainage pipe.
Frosting Occurs	The ambient temperature is low and the machine is waiting for defrost.	This is a normal phenomenon and the dehumidifier has an automatic defrost function.

TECHNICAL SPECIFICATION

Power Source	AC 220-240V 50Hz
Input Current @ Rated Load	4.7A @ 27°C RH 60%, 5.7A @ 30°C RH 80%
Power	950W @ 27°C RH 60%, 1300W @ 30°C RH 80%
IP Rating	IP22
Dehumidifying Extraction Rate	70 litres/day @ 30°C RH 80%
Suction Pressure (Low - High)	0.5Mpa - 1.0Mpa
Discharge Pressure (Low - High)	1.5Mpa - 2.5Mpa
Max. Air Flow Rate	400m ³ /h
Operating Temperature	5°C - 35°C
Refrigerant	R290 (Hydrocarbon Propane), 280g
Weight	40kg
Dimensions (LxWxH)	545mm x 460mm x 870mm Handle Down 545mm x 460mm x 952mm Handle Up
Working Space	50 - 120m ²

SAFETY SYMBOLS

	Read the manual and safety instructions before use		Do not cover when in use
	Indoor use only		Warning: Risk of Fire, Flammable Gas (R290)

MAINTENANCE



WARNING: ALWAYS UNPLUG THE DEHUMIDIFIER BEFORE PERFORMING ANY CLEANING OR MAINTENANCE OPERATIONS.

CLEANING THE CABINET

- Use a soft damp cloth to clean the exterior.
- Never use harsh chemicals or abrasive cleaning agents as these may damage the casing finish.

CLEANING THE CARBON AIR FILTER

1. At the front of the machine, pull the filter out sideways, using the tab.

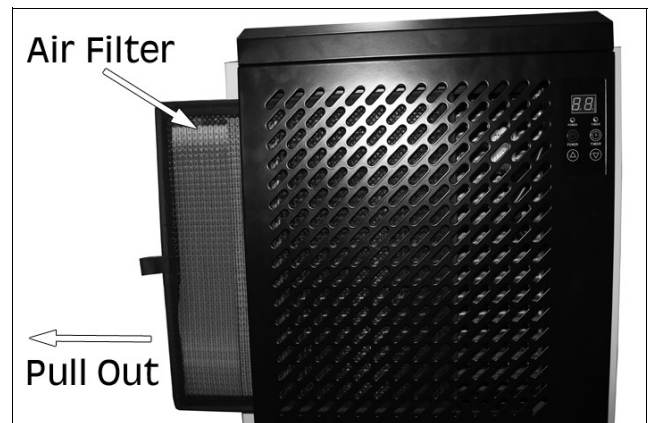

2. Wash the filter under running water to remove any dust and dirt.
3. Allow the filter to dry naturally.
4. Refitting is the reverse process.

The frequency depends on the duration and the level of dust in the environment. If the machine is being used regularly, it is recommended that you clean the filter every 2 weeks.

STORAGE

- Unplug from the mains socket.
- Clean and reinstall the filter.
- Cover the dehumidifier to prevent dust getting into the workings.

COMPONENT PARTS DIAGRAM

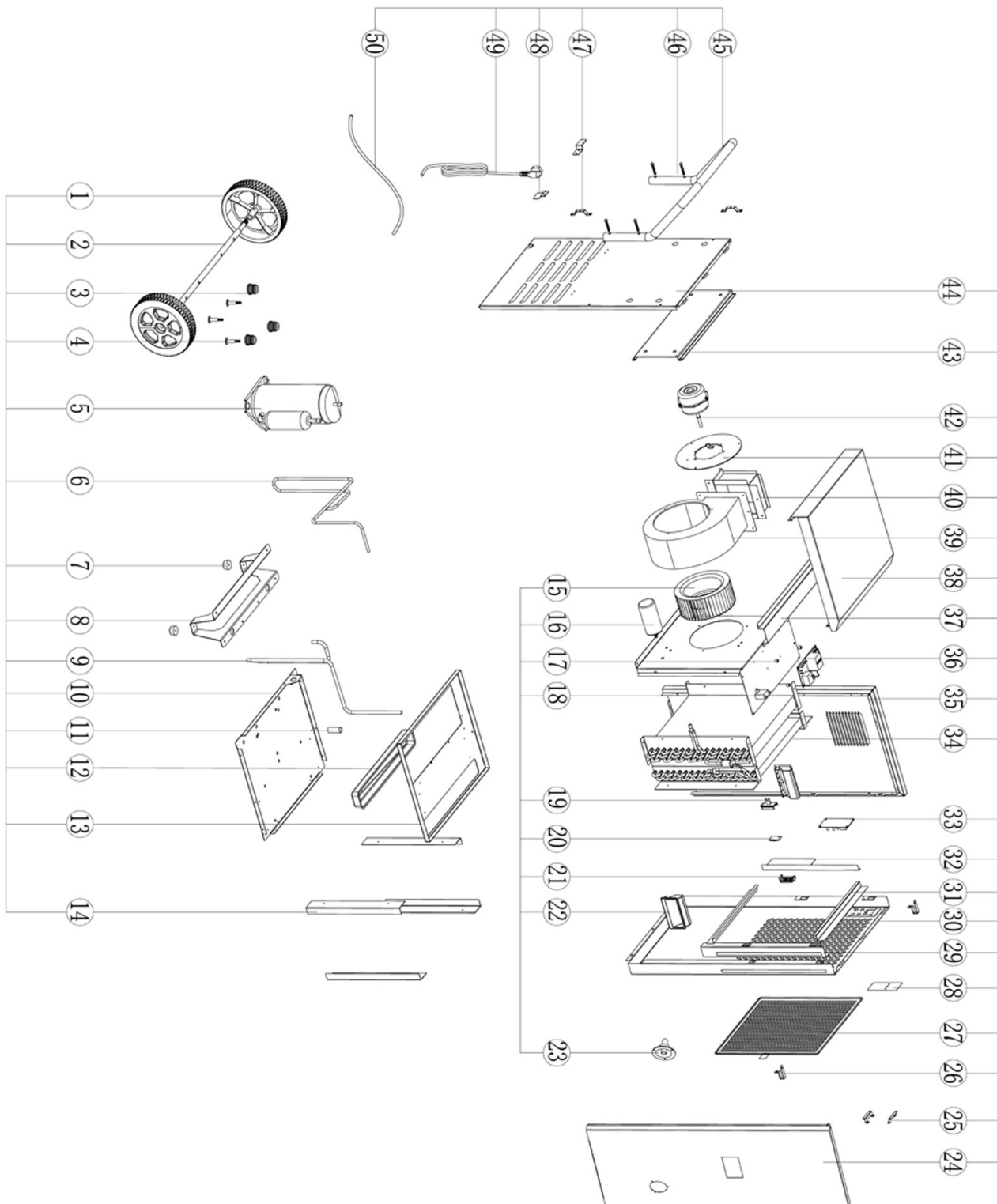

COMPONENT PARTS LIST

No	Description
1	197mm Wheel
2	16mm x 545mm Wheel Axle
3	Compressor Mat
4	M8 x 40 Bolt
5	Compressor
6	Discharge Pipe
7	Rubber Foot
8	Foot Bracket
9	Suction Pipe
10	Base Plate
11	16mm x 40mm Outlet
12	Water Tank
13	Middle Partition
14	Main Support Bar
15	Fan
16	Compressor Capacitor
17	Fixed Support
18	Motor Capacitor
19	Sensor Support
20	Humidity Sensor
21	Sensor Cover Plate
22	Side Handle
23	Water Pipe Joint
24	Left Side Panel
25	Fixed Support

No	Description
26	Upper Cover Screw Hole Stop Strip
27	Air Filter
28	Control Panel Sticker
29	Front Cover Support Plate
30	Front Cover
31	Filter Screen Limit Strip 1
32	Filter Screen Limit Strip 2
33	Control Panel
34	Heat Exchanger Assembly
35	Right Side Panel
36	Main Control Board
37	Head Support Bar
38	Top Panel
39	Duct Assembly
40	Air Outlet
41	Duct Assembly Plate
42	Motor
43	Handle Support Bar
44	Back Panel
45	Handle
46	M6 x 35mm Handle Bolt
47	Screw Hole Support Frame
48	Power Cable Storage Bracket
49	Power Cable
50	Drainage Pipe

DECLARATION OF CONFORMITY - UKCA



Hemnall Street, Epping, Essex, CM16 4LG

DECLARATION OF CONFORMITY

This is an important document and should be retained.

We hereby declare that this product(s) complies with the following legislation:

The Electromagnetic Compatibility Regulations 2016

The Supply of Machinery (Safety) Regulations 2008

The Restriction of the Use of Certain Hazardous Substances in Electrical and Electronic Equipment Regulations 2012

The following standards have been applied to the product(s):

IEC 62321-4:2013+AMD1:2017 CSV, IEC 62321-7-1:2015, IEC 62321-7-2:2017, IEC 62321-1:2013, IEC 62321-2:2013, IEC 62321-5:2013, IEC 62321-6:2015, IEC 62321-8:2017, IEC 62321-3-1:2013, ISO 17075:2017, EN IEC 61000-3-2:2019/A1:2021, EN 60335-2-40:2003/A13:2012, EN 62233:2008, EN IEC 61000-3-2:2019/A1:2021, EN IEC 55014-1:2021, EN IEC 55014-2:2021, EN IEC 61000-3-11:2019

The technical documentation required to demonstrate that the product(s) meet(s) the requirement(s) of the aforementioned legislation has been compiled and is available for inspection by the relevant enforcement authorities.

The UKCA mark was first applied in: 2022

Product Description: Dehumidifier
Model Number(s): IDH70L
Serial/Batch Number: Refer to product/packaging label
Date of Issue: 11/06/2024

Signed:

J.A Clarke

Director

DECLARATION OF CONFORMITY - CE



Clarke[®]
INTERNATIONAL

Fitzwilliam Hall, Fitzwilliam Place, Dublin 2

DECLARATION OF CONFORMITY

This is an important document and should be retained.

We hereby declare that this product(s) complies with the following legislation:

2014/30/EU *Electromagnetic Compatibility Directive*
2006/42/EC *Machinery Directive*
2011/65/EU *Restriction of Hazardous Substances (RoHS) Directive*

The following standards have been applied to the product(s):

*IEC 62321-4:2013+AMD1:2017 CSV, IEC 62321-7-1:2015, IEC 62321-7-2:2017, IEC 62321-1:2013,
IEC 62321-2:2013, IEC 62321-5:2013, IEC 62321-6:2015, IEC 62321-8:2017, IEC 62321-3-1:2013,
ISO 17075:2017, EN IEC 61000-3-2:2019/A1:2021, EN 60335-2-40:2003/A13:2012, EN 62233:2008,
EN IEC 61000-3-2:2019/A1:2021, EN IEC 55014-1:2021, EN IEC 55014-2:2021,
EN IEC 61000-3-11:2019*

The technical documentation required to demonstrate that the product(s) meet(s) the requirement(s) of the
aforementioned legislation has been compiled and is available for inspection by the relevant enforcement
authorities.

The CE mark was first applied in: 2022







Product Description: Dehumidifier
Model Number(s): IDH70L
Serial/Batch Number: Refer to product/packaging label
Date of Issue: 11/06/2024

Signed:

J.A Clarke

Director

ASSOCIATED 110V PRODUCTS

<p>EURO5 Generator - PG3800ADV</p>	<p>12" Ventilator/Air Mover - CON305</p>	<p>2.8kW Electric Fan Heater- Devil 3003</p>
		
<ul style="list-style-type: none"> • Max Output:3000W • 5.6HP Petrol Engine • Dims(LWH):600mm x 480mm x 445mm • Part No. 8857854 	<ul style="list-style-type: none"> • Fan Dia.: 12" (300mm) • Air Flow: 3900m3/h • Dims(LWH):375mm x 386mm x 430mm • Part No. 3230480 	<ul style="list-style-type: none"> • Adjustable Thermostat • Weight: 6.15kg • Dims(LWH):400mm x 260mm x 390mm • Part No. 6925125
<p>Transformer - CTR3000</p>	<p>110V Extension Lead - C14EC</p>	<p>Twin LED Work Light & Tripod - SMD84T/110</p>
		
<ul style="list-style-type: none"> • BS4343 Dual Sockets • 3300va with Overload Circuit Protection • Dims(LWH):236mm x 195mm x 265mm • Part No. 3220785 	<ul style="list-style-type: none"> • 16 Amp • 14 Metres • Part No. 3220825 	<ul style="list-style-type: none"> • 2 x 1650 Lumen Floodlights • Internal or External Use IP54 • Adjustable Height upto 1720mm • Part No. 4003640

A SELECTION FROM THE VAST RANGE OF

Clarke®

QUALITY PRODUCTS



AIR COMPRESSORS
From DIY to industrial, Plus air tools, spray guns and accessories.

GENERATORS
Prime duty or emergency standby for business, home and leisure.

POWER WASHERS
Hot and cold, electric and engine driven - we have what you need

WELDERS
Mig, Arc, Tig and Spot. From DIY to auto/industrial.

METALWORKING
Drills, grinders and saws for DIY and professional use.

WOODWORKING
Saws, sanders, lathes, mortisers and dust extraction.

HYDRAULICS
Cranes, body repair kits, transmission jacks for all types of workshop use.

WATER PUMPS
Submersible, electric and engine driven for DIY, agriculture and industry.

POWERTOOLS
Angle grinders, cordless drill sets, saws and sanders.

STARTERS/CHARGERS
All sizes for car and commercial use.



PARTS & SERVICE: 0208 988 7400

Parts Enquiries
Parts@clarkeinternational.com

Servicing & Technical Enquiries
Service@clarkeinternational.com

SALES: UK 01992 565333 or Export 00 44 (0)1992 565335

Clarke® INTERNATIONAL Hemnall Street, Epping, Essex CM16 4LG
www.clarkeinternational.com